



OFFSHORE SERVICES



One Team, One Vision



HIDRAMAR GROUP HOLDING COMPANY

Hidramar Group is a Spanish holding Company operating two shipyards in Canary Islands, Spain. Hidramar, was founded in 1989 by a family originally from the Canary Islands. Both shipyards are located in a Free-Trade Zone. With a strategic position in the middle of the Atlantic Ocean, where maritime routes from three continents are connected (Europe, Africa, and America).

Hidramar group actively supports all the major Oil & Gas drilling contractors and their OEMs, we are proud of our hands-on Shipyard general services and the technical services, we offer 24/7 round the clock to all our customers safely. We have acquired strong MODUs upgrade & repair knowledge including SPS projects through integrated planning with our clients & OEMs.

Our ONE TEAM, ONE VISION strategy helped us in the safe execution of projects in Tenerife and Gran Canaria with local workforce.

In 2019 we spread our wings to provide our services at offshore locations and safely executed projects while in transit on a fixed price contracts.

VISION & MISSION

Our vision

To become a preferred shipyard partner in Canary Islands, Atlantic Ocean for the Global Oil & Gas and Marine industry.

Our mission

To provide cost effective and efficient offshore Project management, marine engineering and quality shipyard general services to our valued clients globally through our highly skilled internal staff.





As our people is the heart of our business,
our commitment goes further.

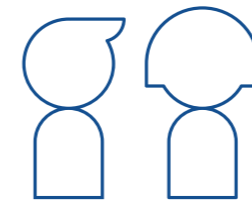

Diversity, gender equity and social Inclusion

It is not just an aim, but a global business policy. It is about our Group welcoming the talents and ideas of people with different backgrounds, experiences, and attitudes to encourage our continued success in providing clients with the high-quality service.



Global Responsibility & Sustainability

Our team consciously works together to protect the environment and have a positive impact on the communities where we live and work. We have internship programs that allow us to collaborate with local and international universities, improving opportunities to young people.

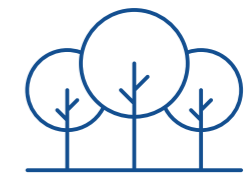

Hidramar Group Green

We continuously work to recognize and promote more sustainable alternatives through operational efficiencies, all in an effort to manage and reduce Shipyards effect on the environment.

QUALITY, HEALTH, SAFETY, ENVIRONMENT AND SUSTAINABILITY

Hidramar Group operates a comprehensive integrated quality and HSE management system. We are constantly seeking to improve and to ensure that our organizational structure keeps up with other leading international companies standards.

Our quality Management System is based on ISO 9001:2015, our Health and Safety Management System is based on ISO 45001:2018 and our Environmental Management System is based on ISO 14001:2015, all certified by Lloyd's Register.



Q1-3177



7-1-1364



INTERNATIONAL OFFSHORE SERVICES

The combination of our commitment in term of quality, safety, on-time delivery, supported by our international expertise, facilitate the high-quality services of engineering, construction, fabrication and cost-effective we provide in the Oil and Gas industry.

Based on our flexibility and our commitment to satisfy our clients, we can provide services at offshore.

At offshore project locations and on transit, we develop a tailor-made execution and control plan to execute the safety and deliver on time.

Our willing is to be the preferred partner of our clients and to build up a long-term business relationship.



Scan me!

If you want to watch more!



OFFSHORE CONTAINERS HUBS AROUND THE WORLD

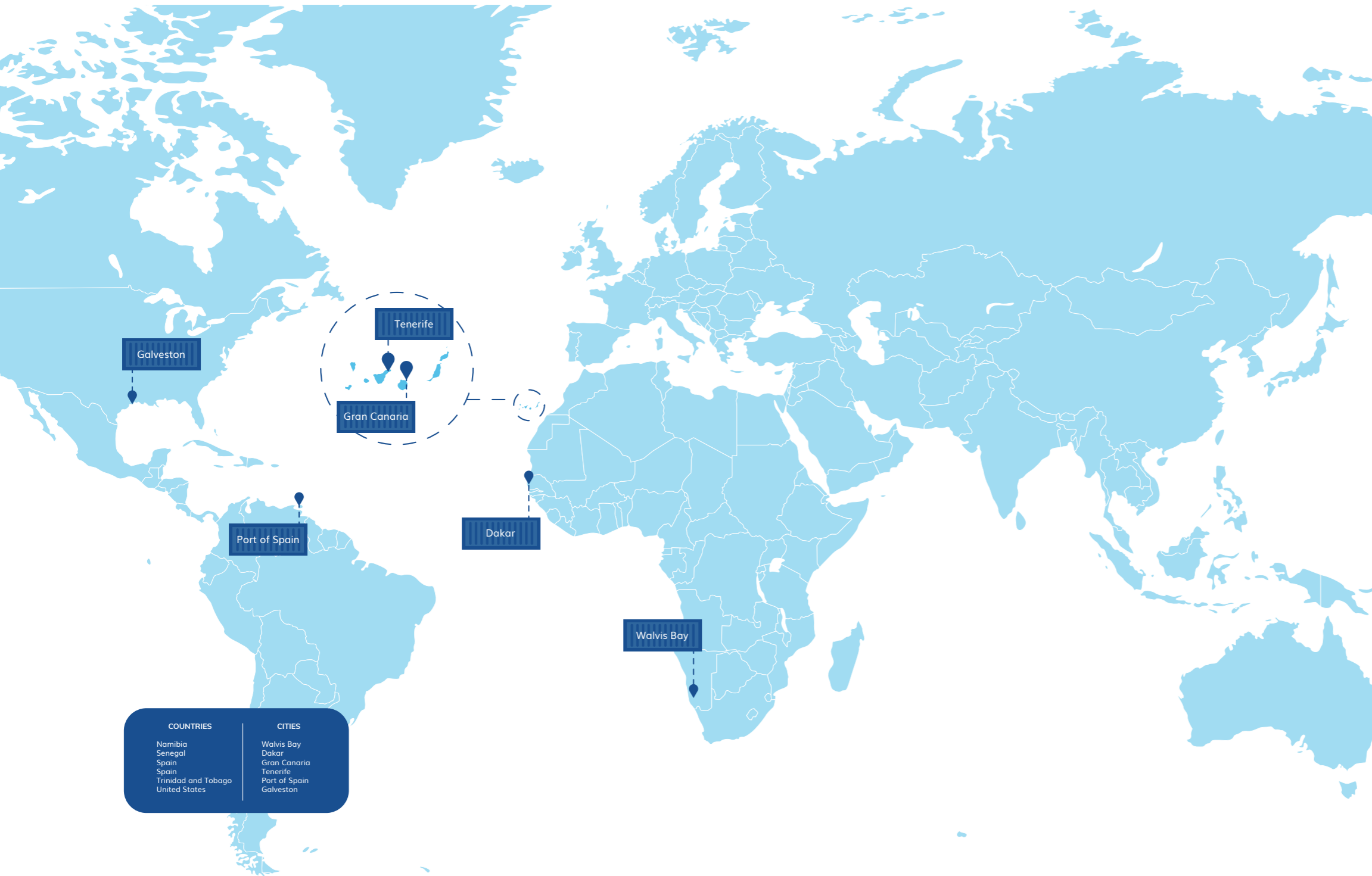

We offer international offshore services anywhere you need it. Our certified offshore containers have all the needed equipment to execute pressure relief valve testing and recertification, lifting gear certification, hydraulic hoses manufacturing and IRATA certified teams.

All our offshore crew members are fully offshore certified (OGUK medical-BOSIET) able to board all drilling units globally.

Our offshore containers workshops are located at various hubs to provide quickest services to our clients globally.

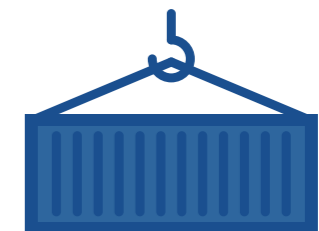

Certified Offshore 20' CSC -DNV
2.7-1 Containers.

WELDING MACHINE'S CONTAINER

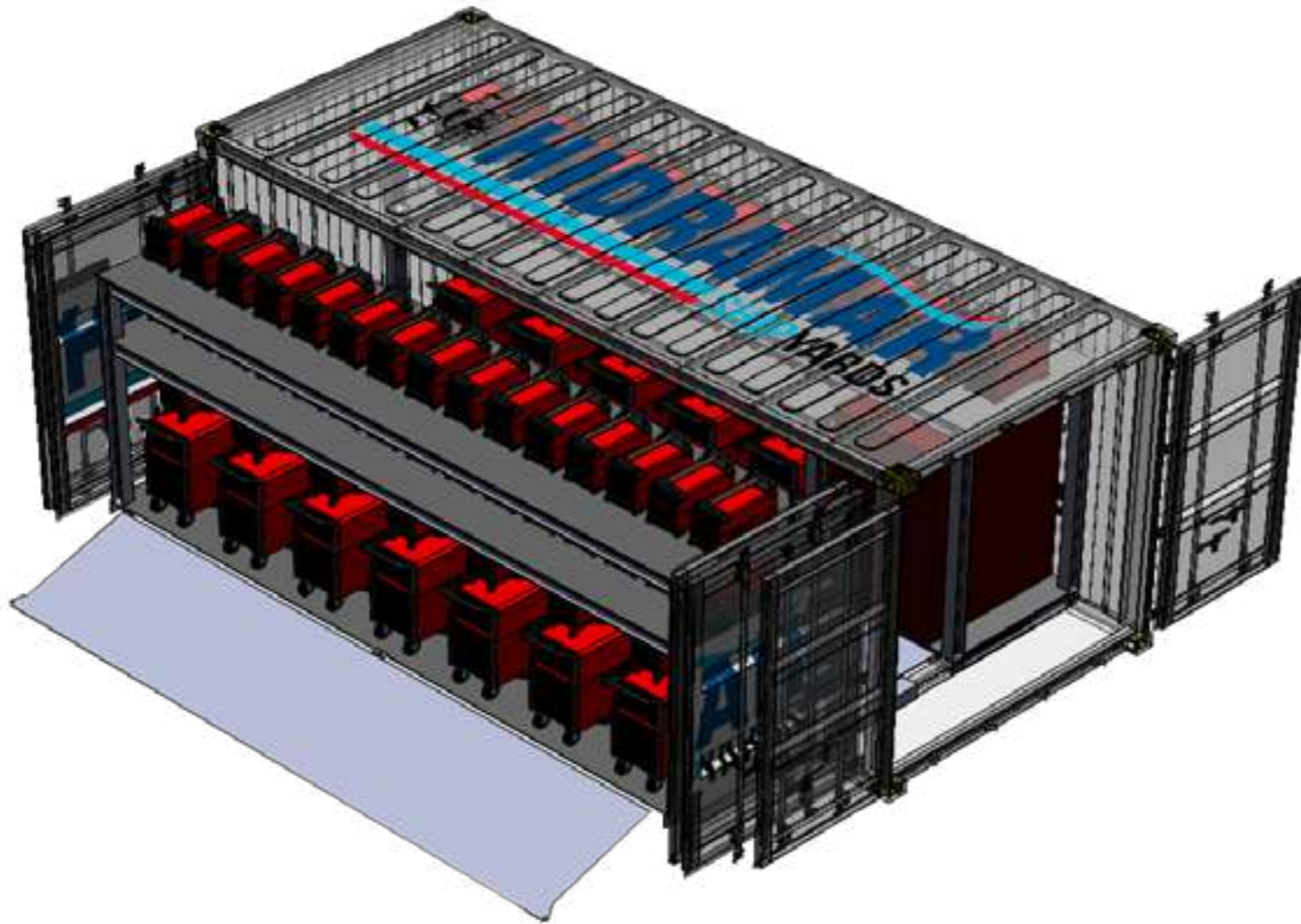

STOCK	MACHINE	DESCRIPTION
39	TIG / ELECTRODE	INVERTEC 270SX
15	MIG FLUX-CORED WELDERS	CV-450 & CV-510
01	FRONIUS ALUMINIUM	TPS 400i LSC ADV

KITS OF HOSES, NOZZLES, WELDING GUNS, ETC.

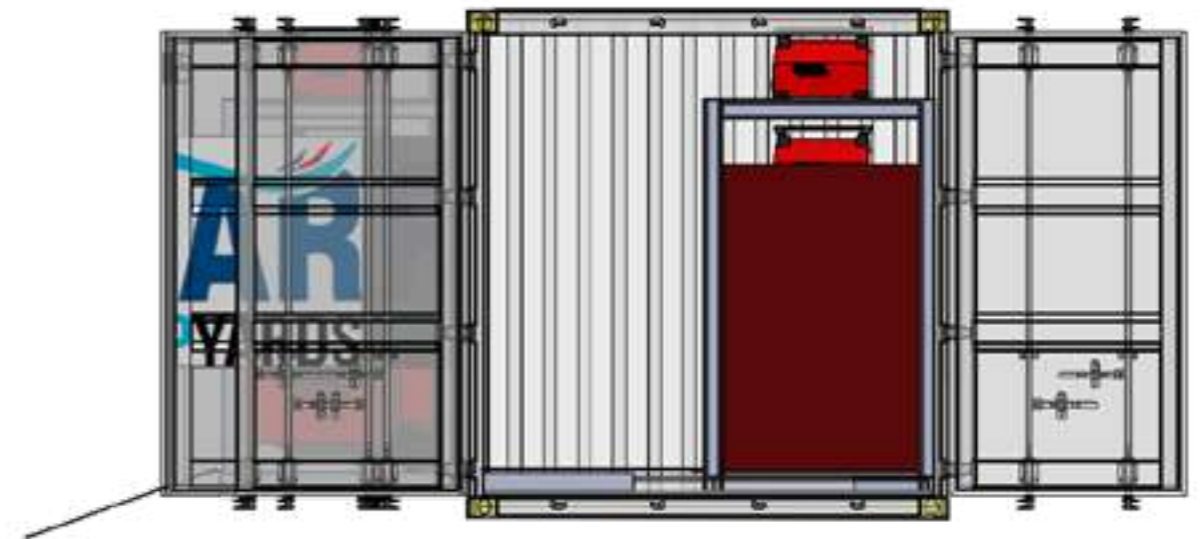

Scan me!
If you want to watch more!

POWER SUPPLIERS CONTAINER

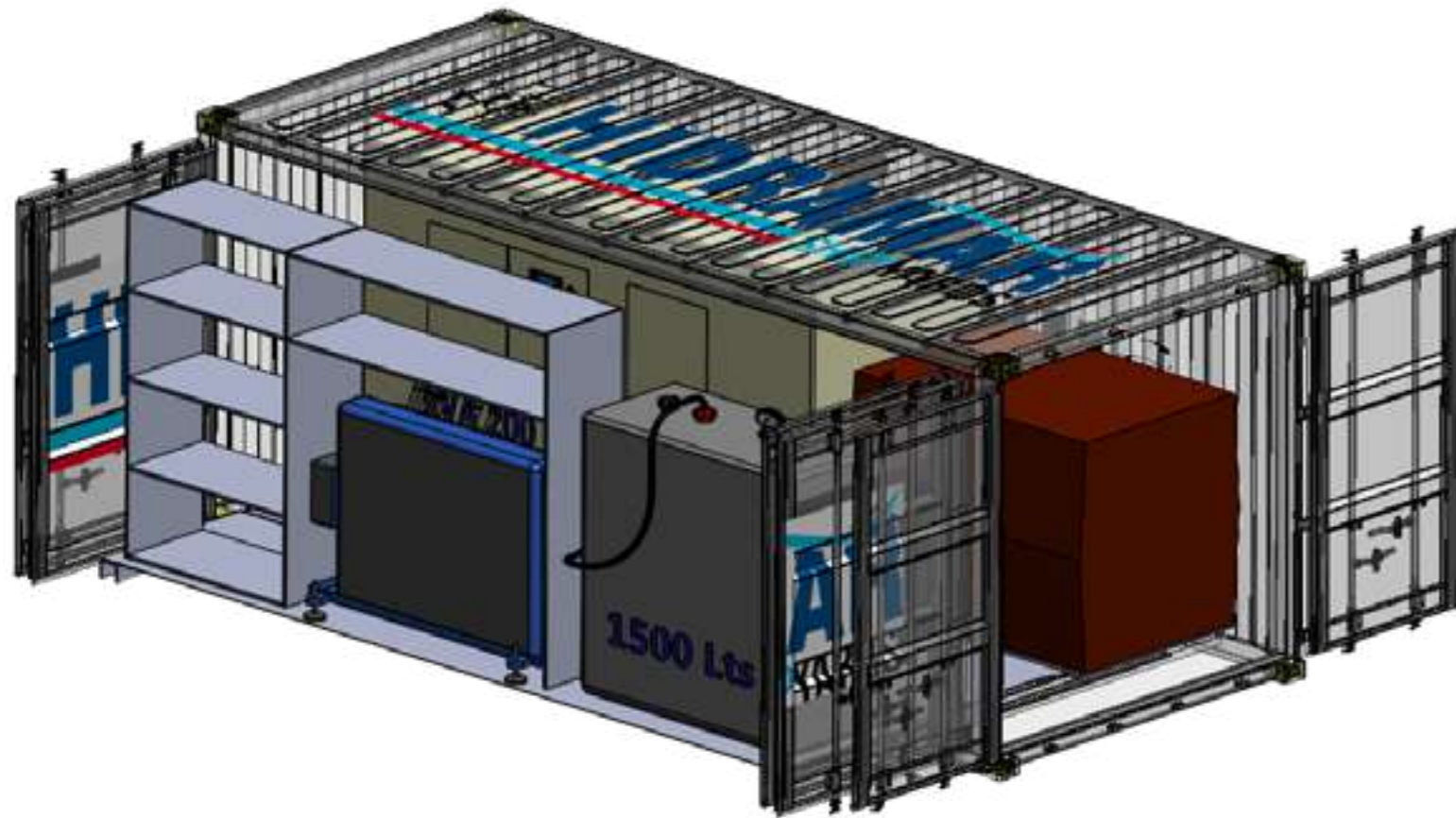

STOCK	MACHINE	DESCRIPTION
01	DIESEL GENERATOR	500 KVA
01	DIESEL COMPRESSOR	10000 l/min @12 Bar
01	HYDRAULIC UNIT & TEST BENCH	350 Bar
01	FUEL DEPOSIT	1500 lts.

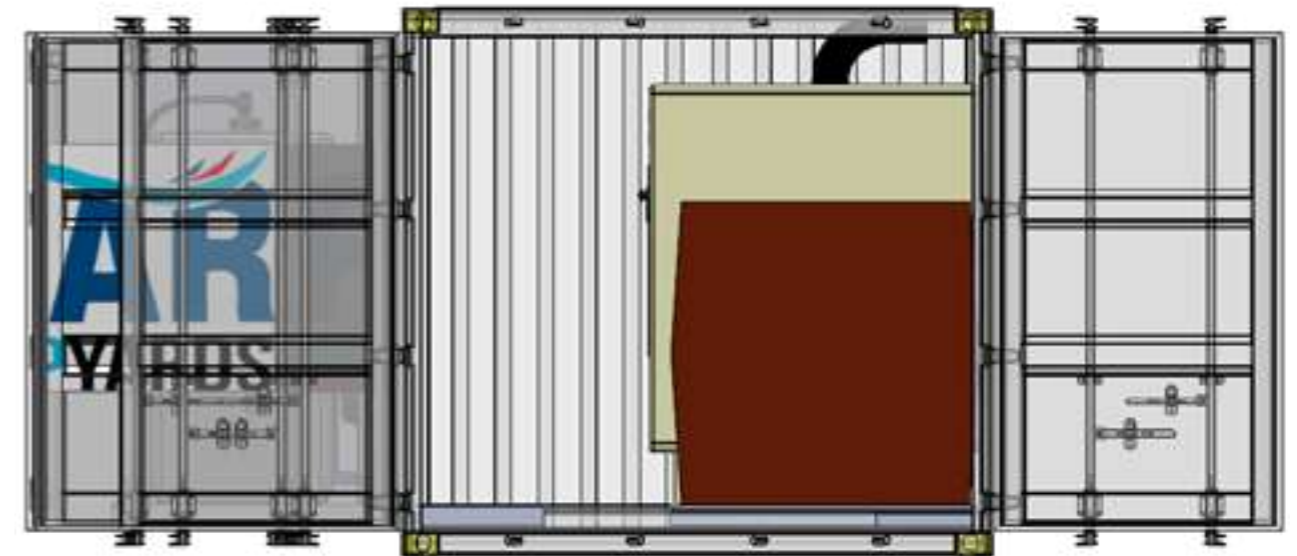

Scan me!
If you want to watch more!

HYDROBLASTING AND PAINTING CONTAINER

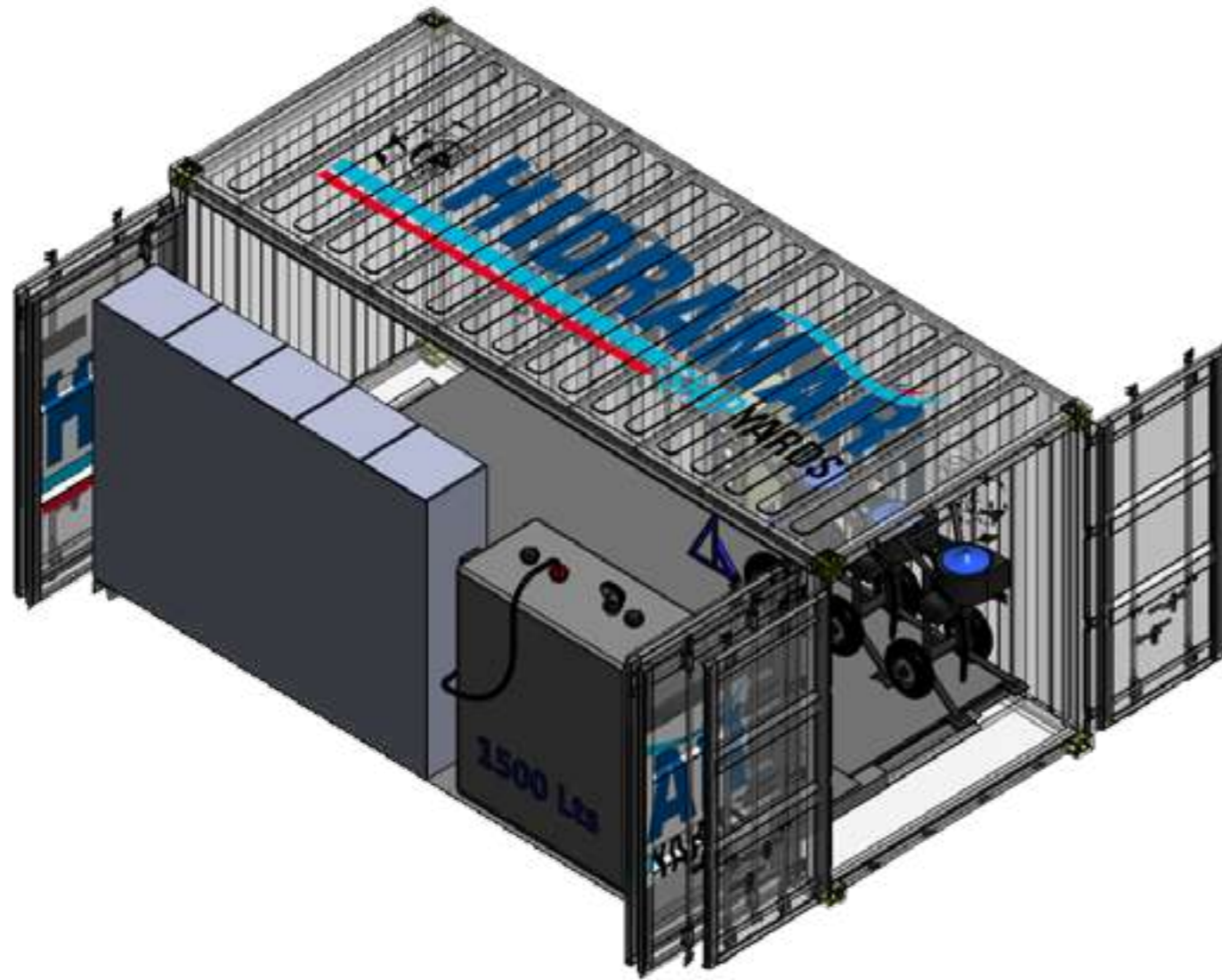

STOCK	MACHINE	DESCRIPTION
03	AIRLESS SPRAYERS GRACO	XL 6500
01	UHP MACHINE – AQUAJET 204	40 l/min @ 3000 Bar
01	UHP SPIDERJET 3000 Bar	200 mts2 /10 hrs
01	FUEL DEPOSIT	1500 lts.
FILTERS, FITTINGS, COUPLINS , HOSES, ETC.		



Scan me!
If you want to watch more!

FLUSHING CONTAINER

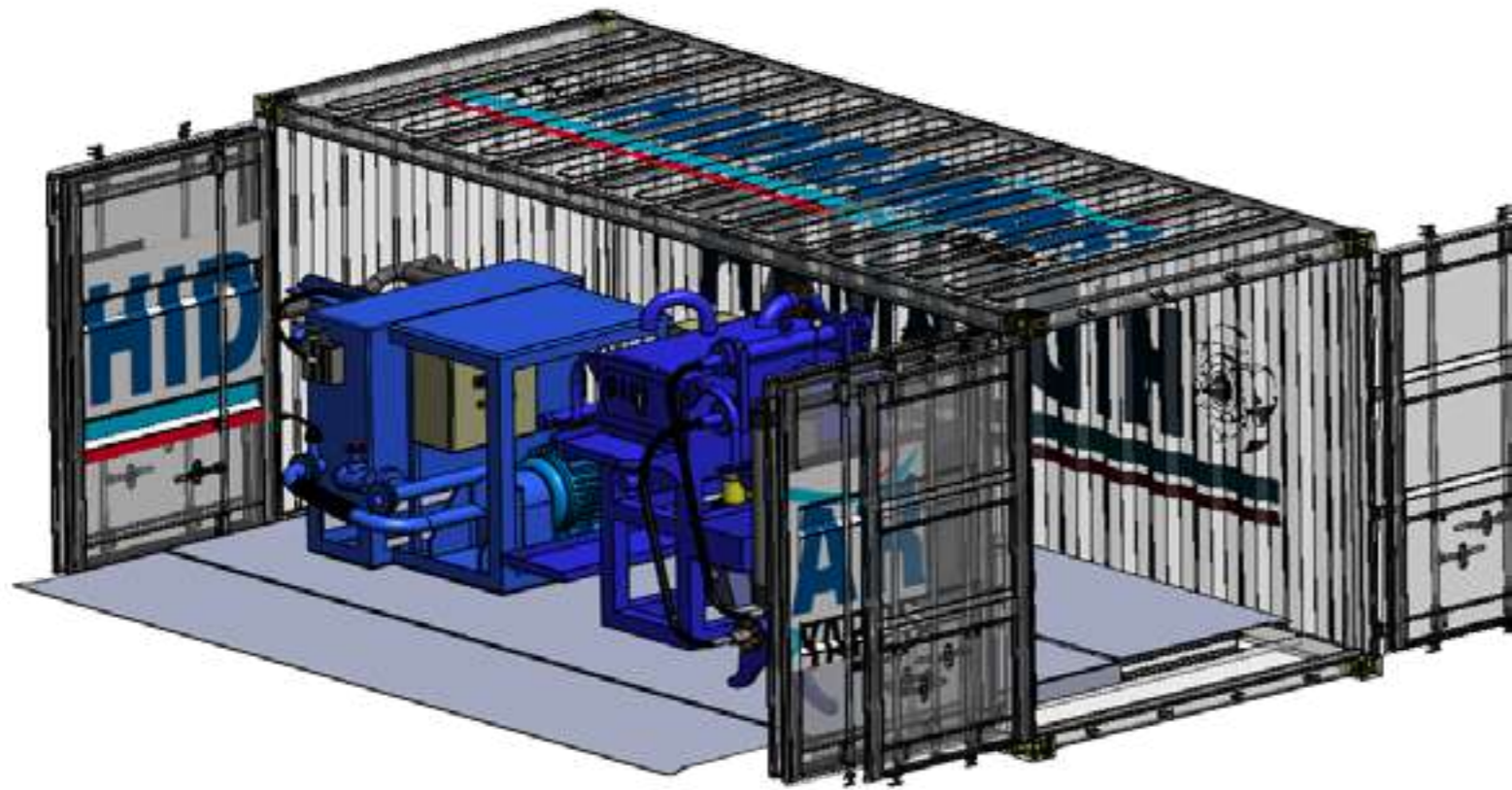

STOCK	MACHINE	DESCRIPTION
02	FLUSHING MACHINE	15 Kw. 250 liters/min
01	UHP MACHINE – AQUAJET 204	40 l/min @ 3000 Bar
KIT FILTERS, FITTINGS, COUPLINS , HOSES, ETC		

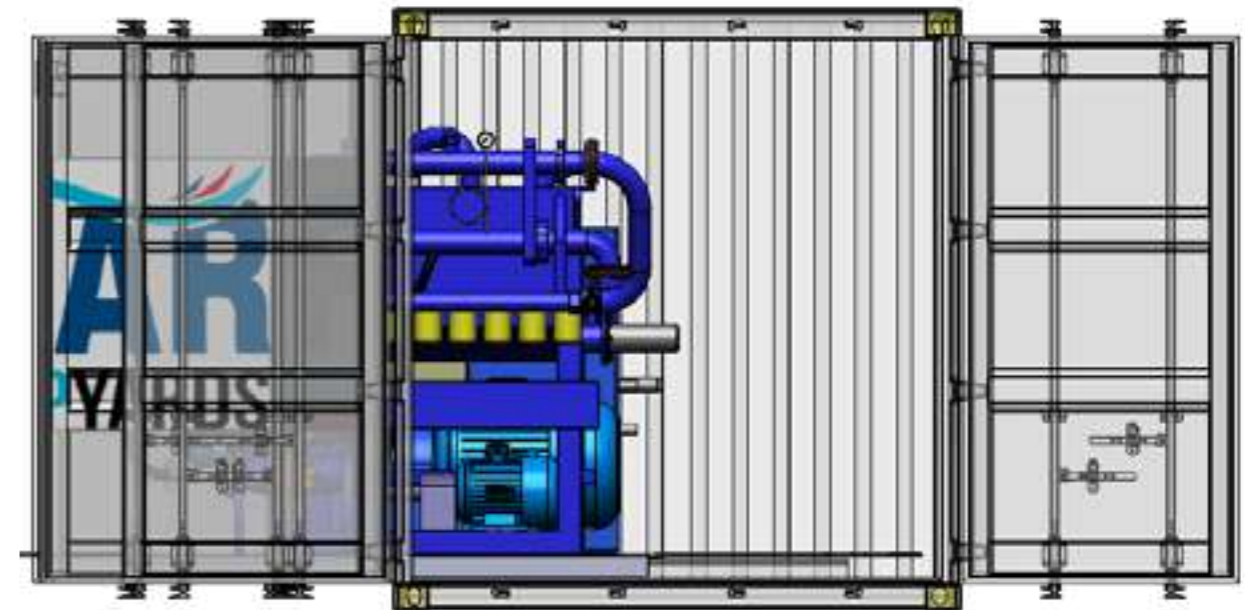

Scan me!
If you want to watch more!

WAREHOUSE CONTAINER

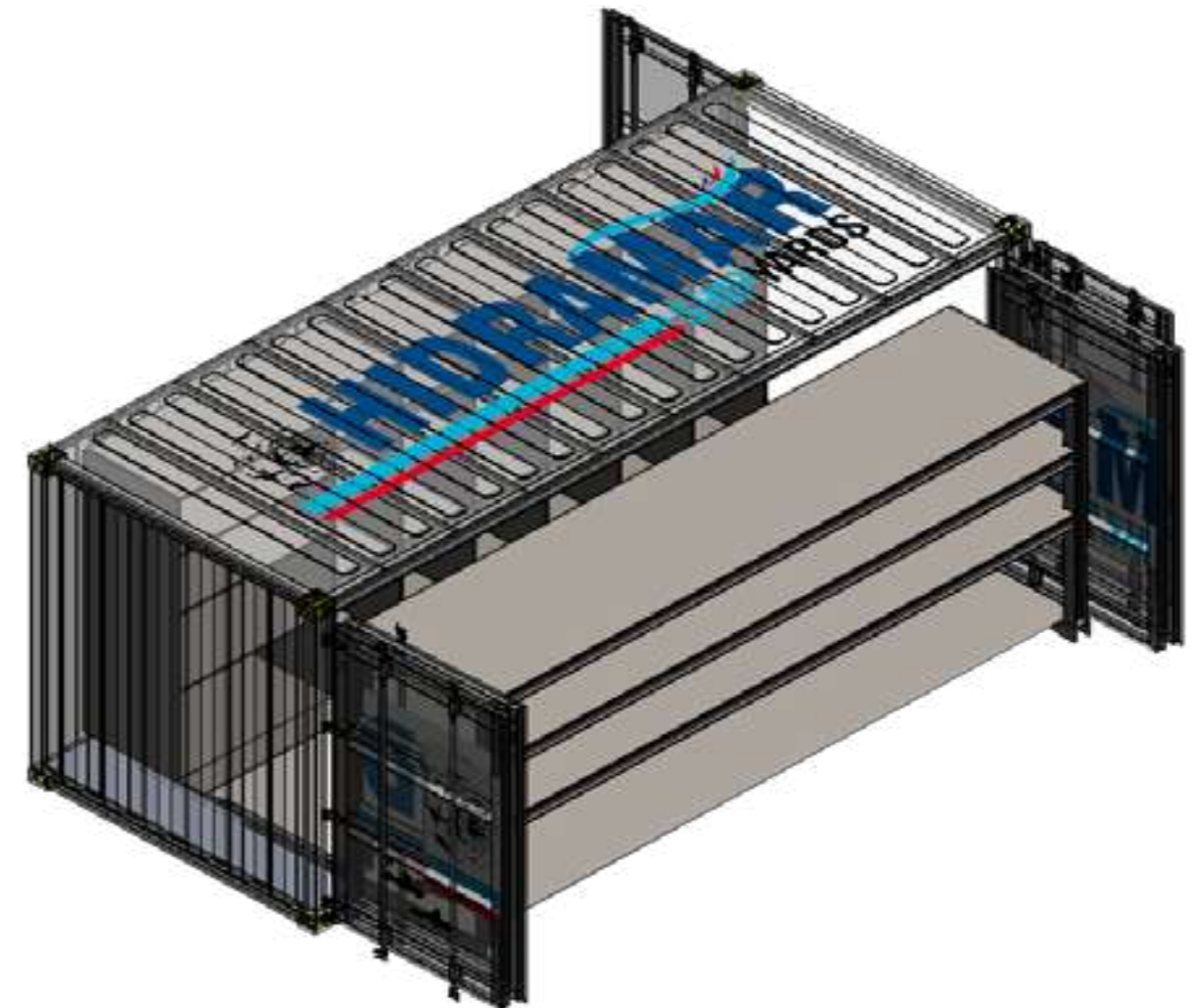
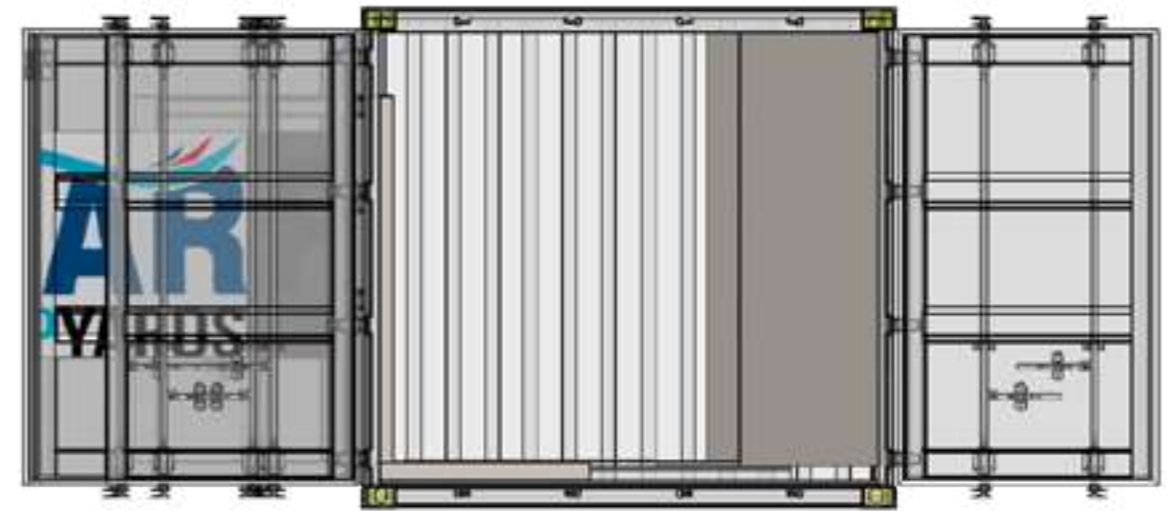
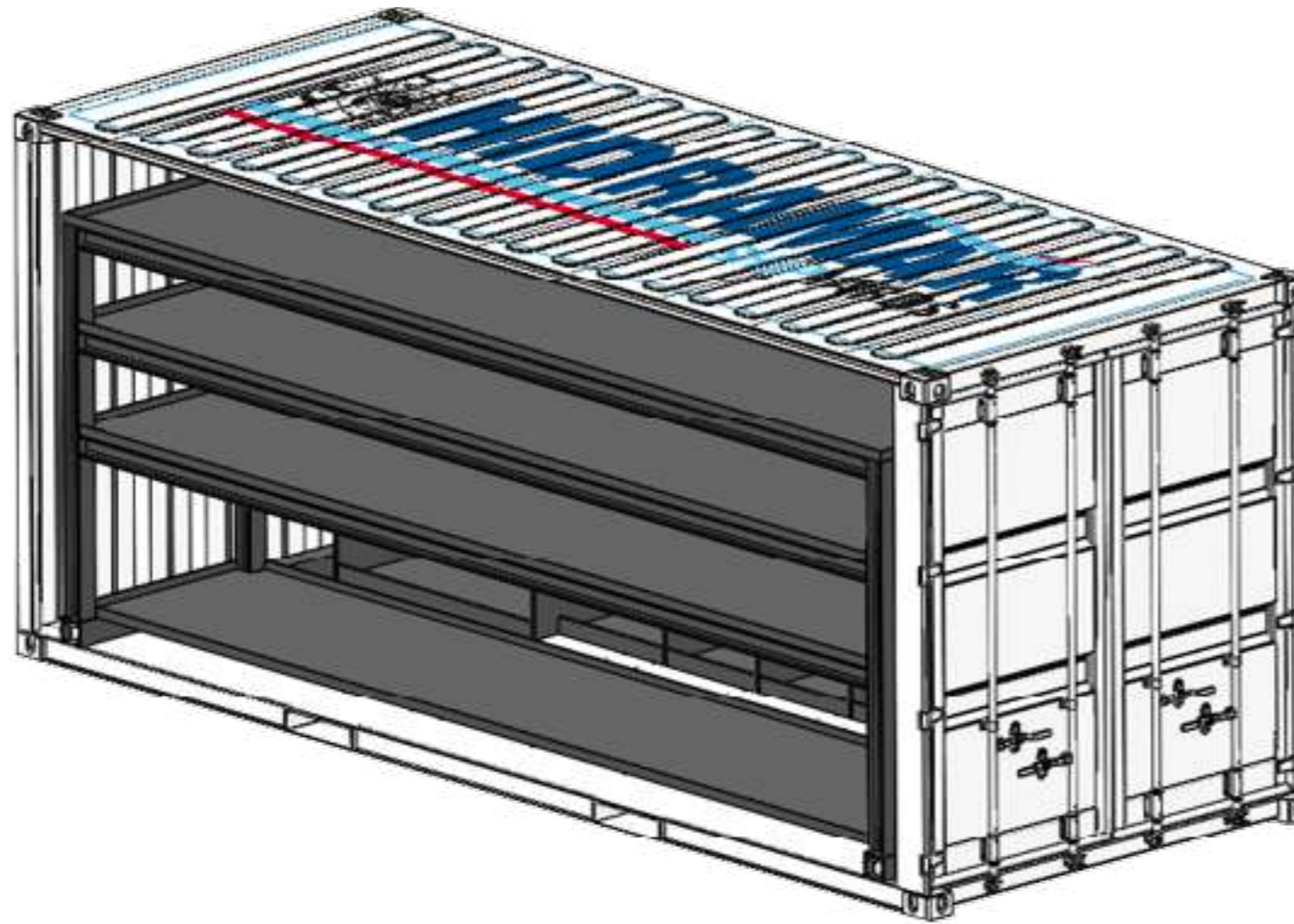

Scan me!
If you want to watch more!

ROPE ACCESS

IRATA CERTIFIED

Our IRATA team can perform works at height safely. As active member of IRATA (5080/O), our team is ideally suited to working on offshore installations and rigs.

Works at height we can support:

- Offshore projects at drilling location and while on transit.
- Heavy mechanical works.
- Painting services.
- Lifting operations.
- NDT services.
- Drops survey.





MECHANICAL REPAIR
SERVICES
HYDRAULIC AND
PNEUMATIC



DROPS INSPECTION

Dropped objects can cause serious injuries or fatality and Hidramar Group is conscious about the importance of dropped objects prevention and awareness.

Hidramar Group is committed to safety excellence providing efficient services in dropped objects surveys to our clients around the world, in any location both onshore and offshore.

- Dropped objects survey and report for remedial action.
- Failed items list.
- Dropped objects inspections register.



HYDRAULIC HOSE MANUFACTURING ONBOARD, CREATE/UPDATE HOSE REGISTER

Hidramar group has been a reference manufacturing and supplying hoses for industrial, marine and oil & gas sector since 1989. Our hoses have been installed on several vessels and drilling rigs from all over the world with a high performance and durability. We can manufacture hydraulic and pneumatic hoses onboard the rig with the following specifications:

- Metric, gas and Jic threaded connections as well as SAE and CAT flanges.
- Hoses from 1/4" all the range until 2".
- Pressure tests for all the manufactured hoses.
- Truceability tagging.
- Wide variety of fittings in carbon or stainless steels.
- Variety of steel wire braid reinforcements layers for all the range of hoses (R2AT, 4SP).

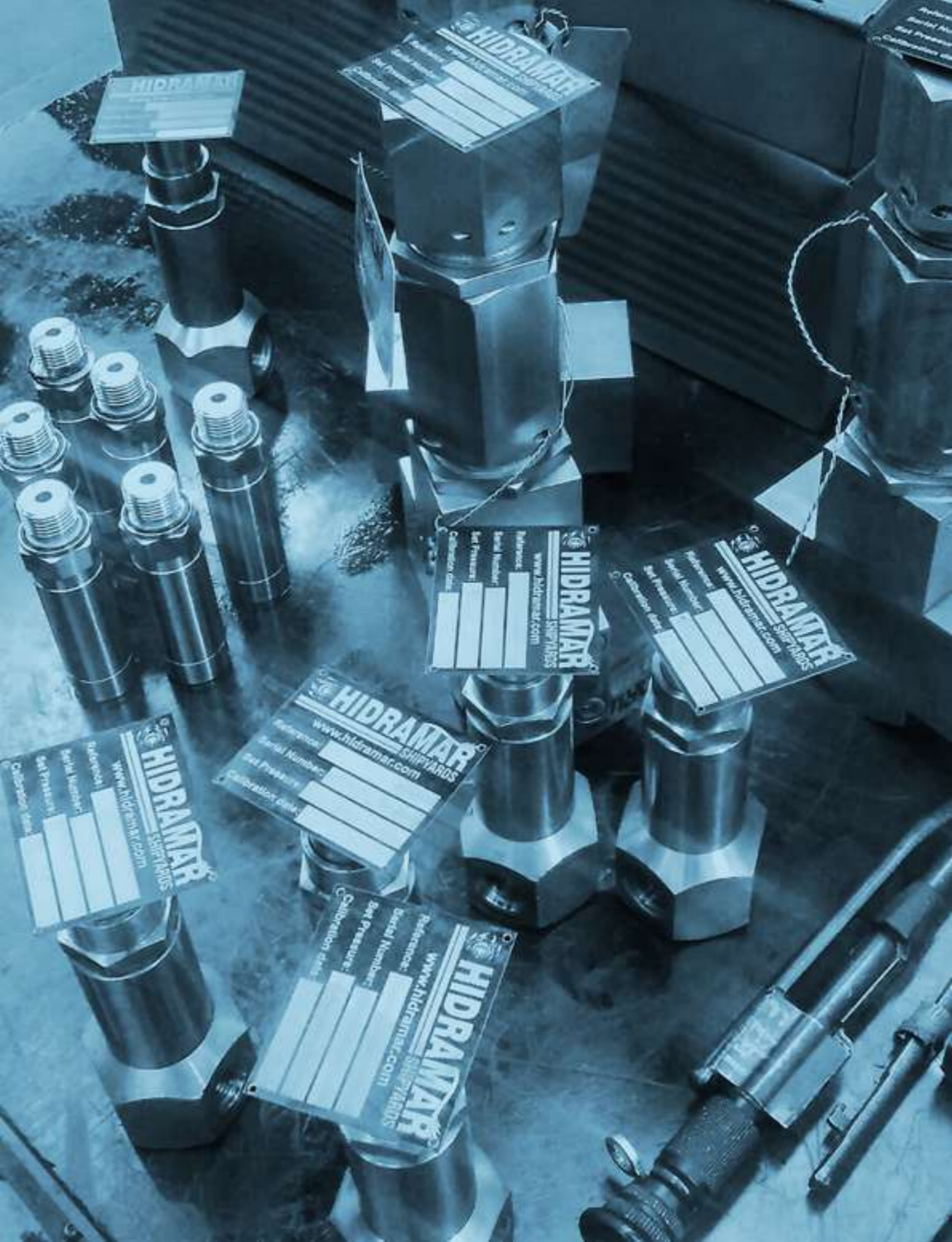

PRESSURE RELIEF VALVES

TESTING AND RECERTIFICATION

We have containerized self-sufficient PRV testing units to ensure a high standard inspection, and maintenance.

We can support:

- Verification of pressure gauges.
- Test and reset relief valves to the operating valves.
- Create update PRV register.



LIFTING GEAR INSPECTION

Hidramar Group provides lifting gear inspection in offshore location, onboard the rig with our mobile workshop DNV Container.

we can support:

- Lifting gear periodic inspection on rig cranes, lifting equipments, drilling tools, overhead cranes, lifeboat.
- All equipment inspected is maintained in a data base in accordance with LOLER regulations and procedures, the certificates are generated as per relevant standards.
- All our personnel are trained to the highest international standards through internal and external courses. Rope access team are also certified to access to the lifting equipment at height, including NDT inspections.



NON DESTRUCTIVE TEST - NDT

Recognized by our clients, here in Hidramar Group we have a multi-skilled team able to ensure a state-of-the-art inspection, with high expertise, our team can easily carry out the following:

- Visual Testing.
- Magnetic Particle Testing.
- Penetrant Testing.
- Conventional Ultrasonic Testing.
- PA Ultrasonic testing.

All our NDT procedures have been developed according to the relevant ISO standards. On specific request, NDT procedures can be developed according to other international standards. Our NDT technicians are qualified ISO 9712 level II.

TENERIFE
SHIPYARDS



HIDRAMAR

OUR TECHNICAL PARTS FOR VESTARICA BEYOND

CLIENTS



- ENSCO DS-1
- ENSCO DS-2
- VALARIS DS-3
- VALARIS DS-4
- VALARIS DS-5
- VALARIS DS-6
- VALARIS DS-7
- VALARIS DS-11
- VALARIS DS-12
- ENSCO 6000
- ENSCO 7500



- CAJUN EXPRESS
- SEDCO EXPRESS
- SEDCO ENERGY
- DEVELOPMENT DRILLER I
- DEEPWATER DISCOVERY
- JACK RYAN
- SEDCO 710
- DEEPWATER POSEIDON
- DEEPWATER PAROS
- DEEPWATER APOLLO
- DEEPWATER OLYMPIA
- DEEPWATER MYLOS
- DEEPWATER CORCOVADO
- DEEPWATER MYKONOS



- WEST TAURUS
- WEST EMINENCE
- WEST CAPELLA
- WEST LEO
- WEST SATURN
- WEST PEGASUS
- WEST POLARIS
- WEST TELLUS
- WEST HERCULES
- WEST GEMINI



- PACIFIC SCIROCCO
- PACIFIC MELTEM
- PACIFIC MISTRAL
- PACIFIC KHAM SIN
- PACIFIC SANTA ANA



CLIENTS



- OCEAN VALIANT
- OCEAN CONFIDENCE



- BOLETTE DOLPHIN



- ODN TAY IV



- FLOATEL

Our skilled offshore workforce is our strength to deliver on state-of-the-art services to our clients safely at offshore location while drilling or at idle.



WWW.HIDRAMAR.COM

comercial@hidramar.com

+34 928 32 78 27/28

Calle Harald Flick, Nave P20,
Las Palmas de Gran Canaria Port , 35008
Canary Islands, Spain

comercial@tenerifeshipyards.com

+34 922 10 49 82

Primera Alineación, Dique del Este,
Santa Cruz de Tenerife Port, 38180
Canary Islands, Spain



UNIÓN EUROPEA
Fondos Estructurales y de Inversión Europeos

